

Item No.: LIT8123BK+MC

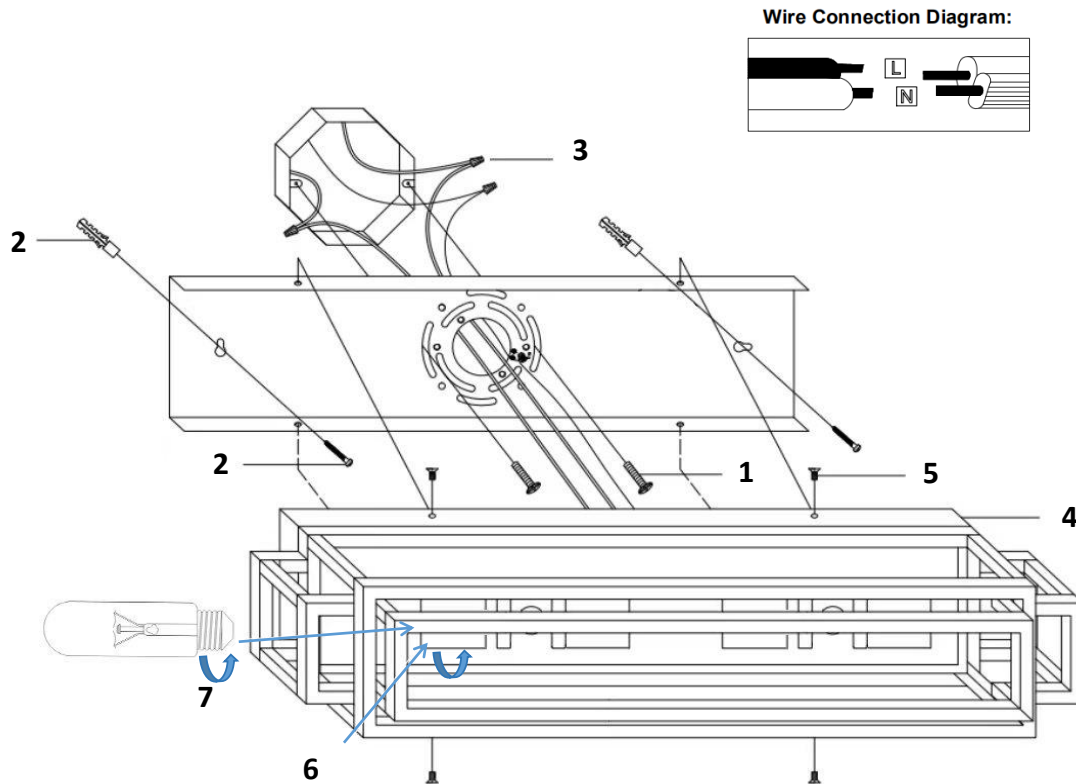

1. Attach mounting plate to the junction box in the wall with outlet box screws (1).
2. Drill holes in the wall aligned with the key-hole located in the mounting plate, insert the plastic anchor to the wall then fasten the mounting plate to the wall using the wood screw 2).
3. Connect the wires in the outlet box to the light fixture wires using the wire connectors (3).
4. Install lighting fixture onto the mounting plate(4) by using screws (5).
5. Insert the socket rings(6) and the bulbs(7).
6. Turn on the lighting fixture.

ATTENTION:

FIXTURE INSTALLATION MUST BE DONE BY LICENSED ELECTRICIAN.
SHUT OFF POWER SUPPLY AT FUSE OR CIRCUIT BREAKER.
USE ONLY THE SPECIFIED BULBS AND DO NOT EXCEED THE MAXIMUM WATTAGE.

BEFORE YOU INSTALL:

1. Check the fixture frame for any physical damage

2. Check all parts to ensure they are not damaged or missing
3. Test all sockets with a bulb for conductivity before “dressing” the fixture
4. If there is any problem, please do not install the fixture, please contact the vendor and solve the problem first.

Instruction Sheet for Item# LIT8123BK+MC