

ASSEMBLY INSTRUCTION

LitUp lighting

Item No.: LIT6733BK

Wire Connection Diagram:

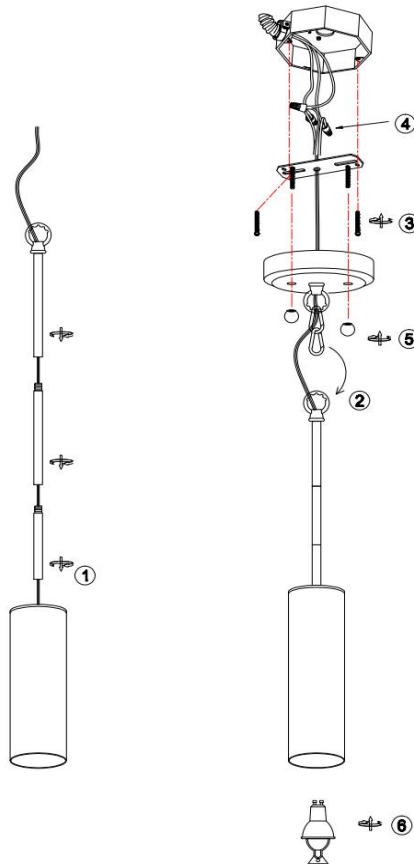
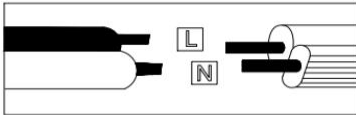

1. Connect the pipes to canopy and frame then tighten them(1).
2. Attach mounting plate to the junction box in the ceiling with outlet box screws (3).
3. Through the wire into the canopy (2) and connect the wires in the outlet box to the light fixture wires using the wire connectors (4).
4. Fix the canopy to the ceiling plate by nuts (5).
5. Insert bulbs (6).
7. Turn on the lighting fixture.

ATTENTION:

FIXTURE INSTALLATION MUST BE DONE BY LICENSED ELECTRICIAN.
SHUT OFF POWER SUPPLY AT FUSE OR CIRCUIT BREAKER.
USE ONLY THE SPECIFIED BULBS AND DO NOT EXCEED THE MAXIMUM WATTAGE.

BEFORE YOU INSTALL:

1. Check the fixture frame for any physical damage.
2. Check all parts to ensure they are not damaged or missing.
3. Test all sockets with a bulb for conductivity before “dressing” the fixture.
4. If there is any problem, please do not install the fixture, please contact the vendor and solve the problem first.