

ASSEMBLY INSTRUCTION

LitUp
lighting

Item No.: LIT6124BK+MC-CL

Wire Connection Diagram:

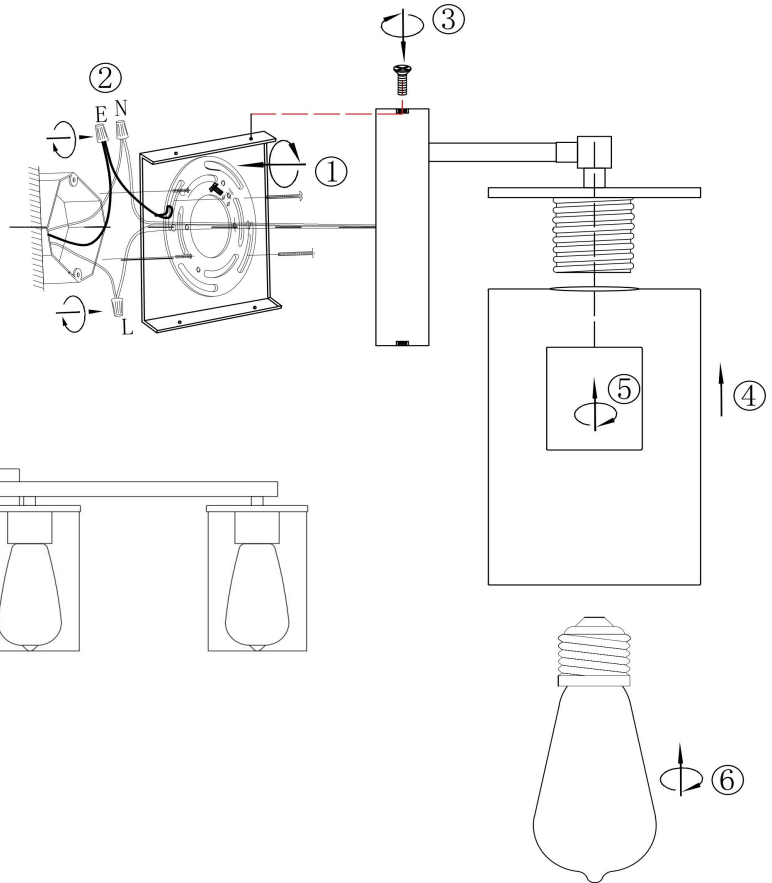
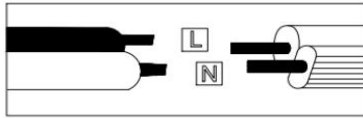

1. Attach mounting plate to the junction box in the wall with outlet box screws (1).
2. Connect the wires in the outlet box to the light fixture wires using the wire connectors (2).
3. Install lighting fixture onto the mounting plate by using screws (3).
4. Insert the glass shade (4) and tighten with the socket ring (5)
5. Insert bulbs (6).
6. Turn on the lighting fixture.

ATTENTION:

FIXTURE INSTALLATION MUST BE DONE BY LICENSED ELECTRICIAN.
SHUT OFF POWER SUPPLY AT FUSE OR CIRCUIT BREAKER.
USE ONLY THE SPECIFIED BULBS AND DO NOT EXCEED THE MAXIMUM WATTAGE.

BEFORE YOU INSTALL:

1. Check the fixture frame for any physical damage.
2. Check all parts to ensure they are not damaged or missing.
3. Test all sockets with a bulb for conductivity before “dressing” the fixture.
4. If there is any problem, please do not install the fixture, please contact the vendor and solve the problem first.