

ATTENTION:

FIXTURE INSTALLATION MUST BE DONE BY LICENSED ELECTRICIAN.
 SHUT OFF POWER SUPPLY AT FUSE OR CIRCUIT BREAKER.
 USE ONLY THE SPECIFIED BULBS AND DO NOT EXCEED THE MAXIMUM WATTAGE.

BEFORE YOU INSTALL:

1. Check the fixture frame for any physical damage
2. Check all parts to ensure they are not damaged or missing
3. Test all sockets with a bulb for conductivity before “dressing” the fixture
4. If there is any problem, please do not install the fixture, please contact the vendor and solve the problem first.

Assembly Steps

1. E, D → A
2. K → J
3. G, H → B
4. F, I → C
5. M, N → L

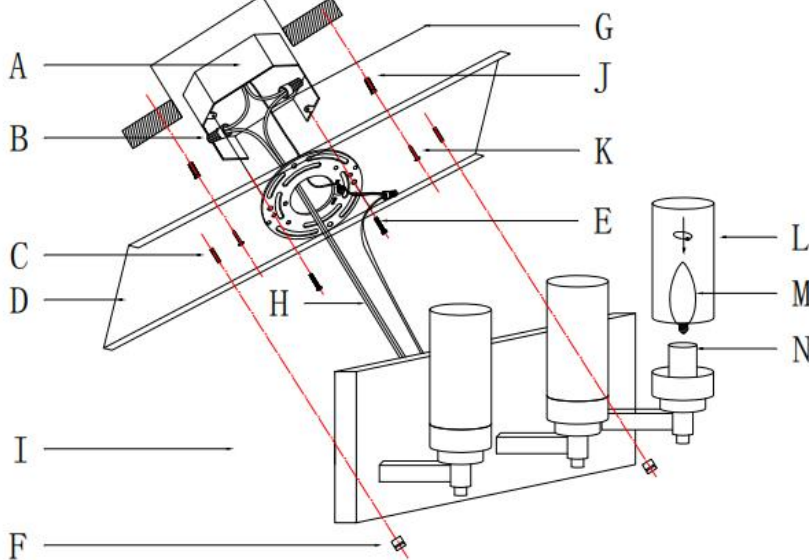
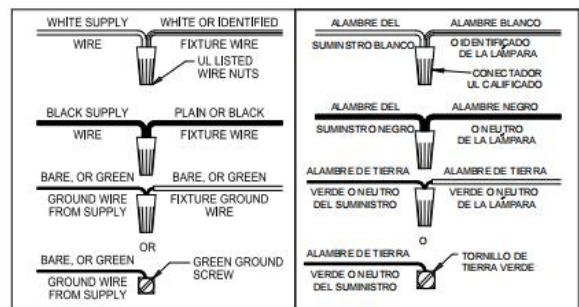

Part included		
QTY	Part Description	Code
0	Junction box	A
3	Wires Nuts	B
2	Mounting screws	C
1	Mounting bracket	D
2	Studs	E
2	Ball nuts	F
0	Leading wires	G
2	Wires	H
1	Canopy	I
2	plastic anchors	J
2	tapping screws	K
3	Glass	L
0	Lighting bulb	M
3	Socket	N